

A Primer on the Radiant EDU Educational Tester

Radiant Technologies, Inc., Albuquerque, NM USA

radiant@ferrodevices.com

Rev D

April 4, 2013



Radiant Technologies, Inc.

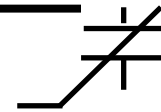

Overview

- Hardware Design
- Circuit Architecture
- Graphical User's Interface
- Charge Measurement
- Ferroelectric Capacitors and Sensor Chips from Radiant
- External Sensor Projects
- Oscilloscope Operation
- Syllabi

Hardware Design

- The test circuitry in Radiant's EDU is implemented with modern surface mount technology and components to reduce costs.
- A USB communications port connects the tester to a host computer.
- Standardized ferroelectric capacitor samples connect to the tester through a built-in TO-18 transistor-type socket.

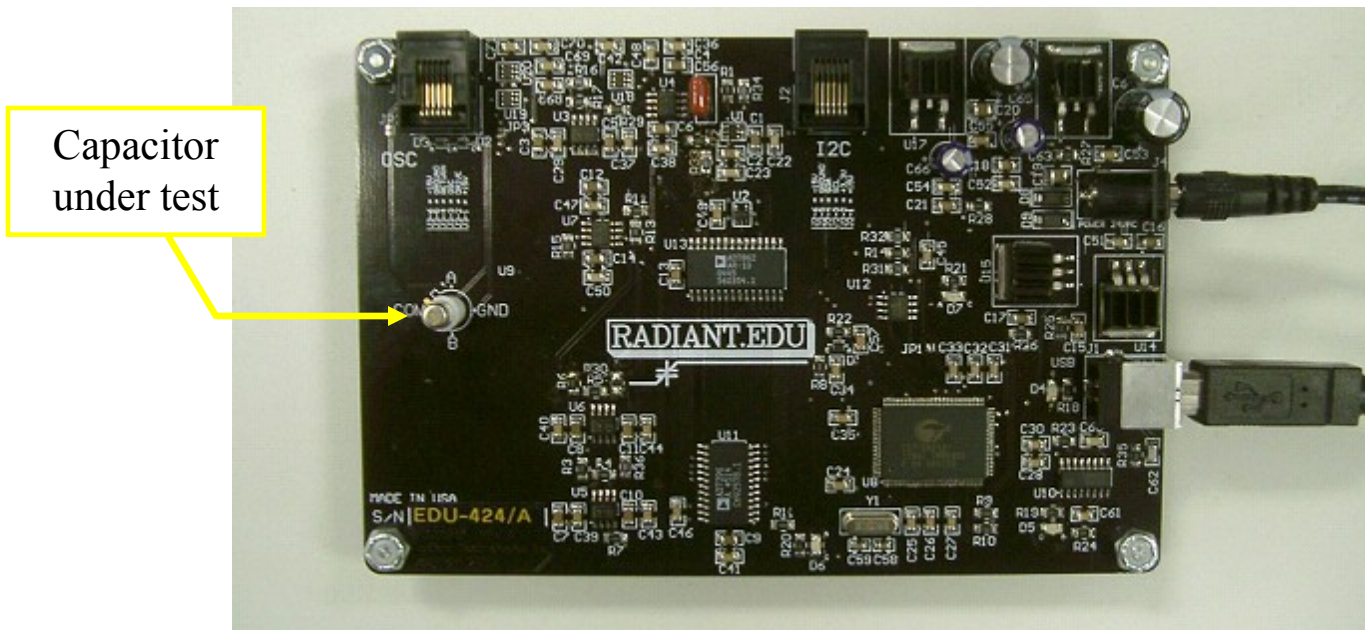

Circuit Architecture

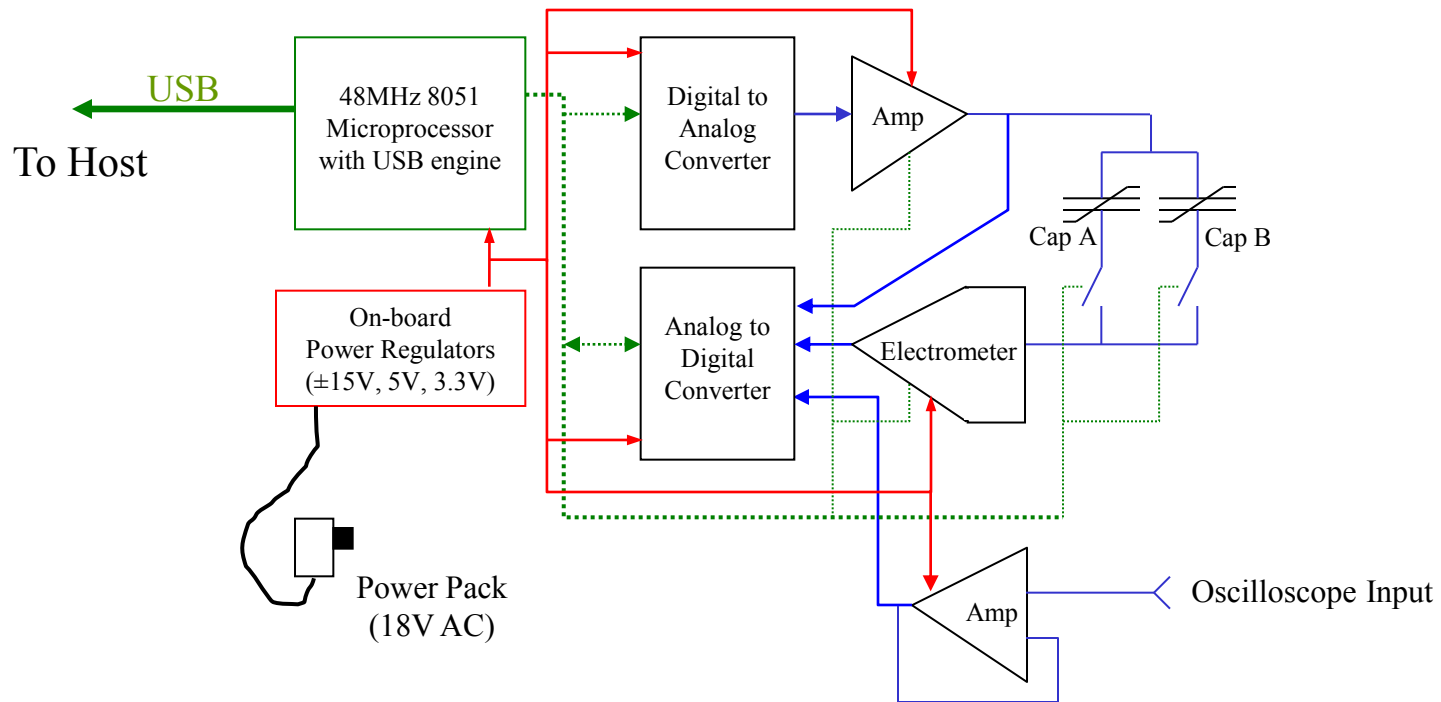

- The EDU has one $\pm 10V$ output and three synchronously captured 12-bit inputs. Its execution clock is $50\mu s$.

Hardware Design

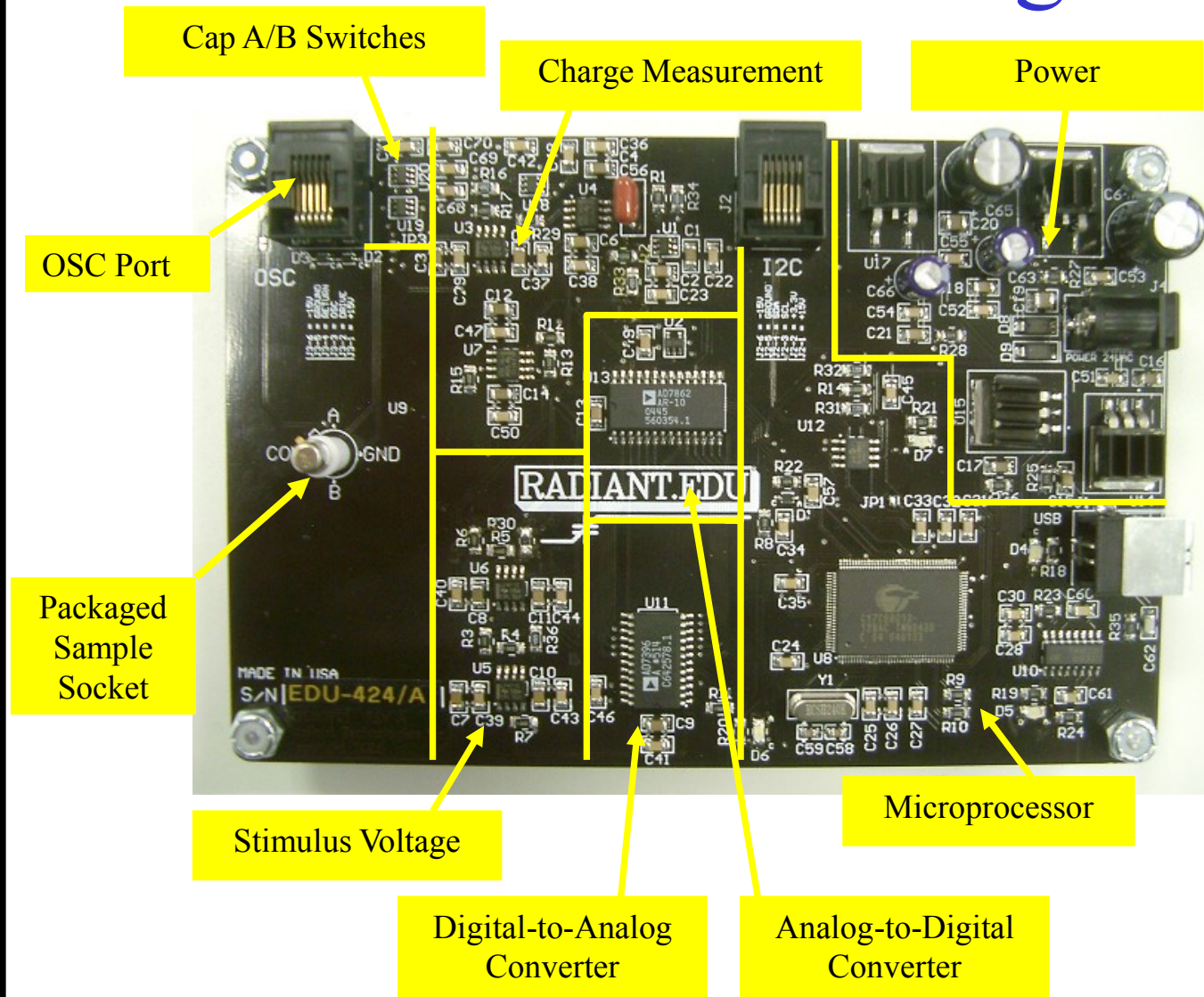
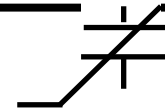

Simple Graphical Users Interface

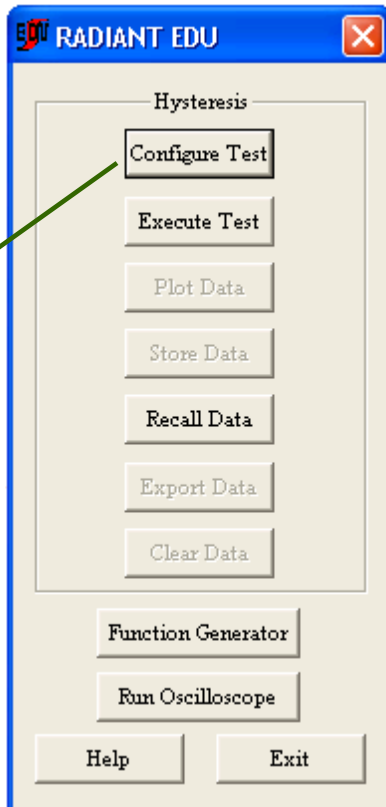

Next page

- Only one measurement task is necessary: Charge vs Voltage vs Time
 - 100Hz to 1Hz frequency range
 - $\pm 10V$ range
- A separate waveform task allows recovery, fatigue, and imprint tests to be executed manually.
- All file formats and export formats are in ASCII but plots may be pasted from the GUI directly into other programs.
- Plotting options include derivatives and measurements vs time.

Simple GUI

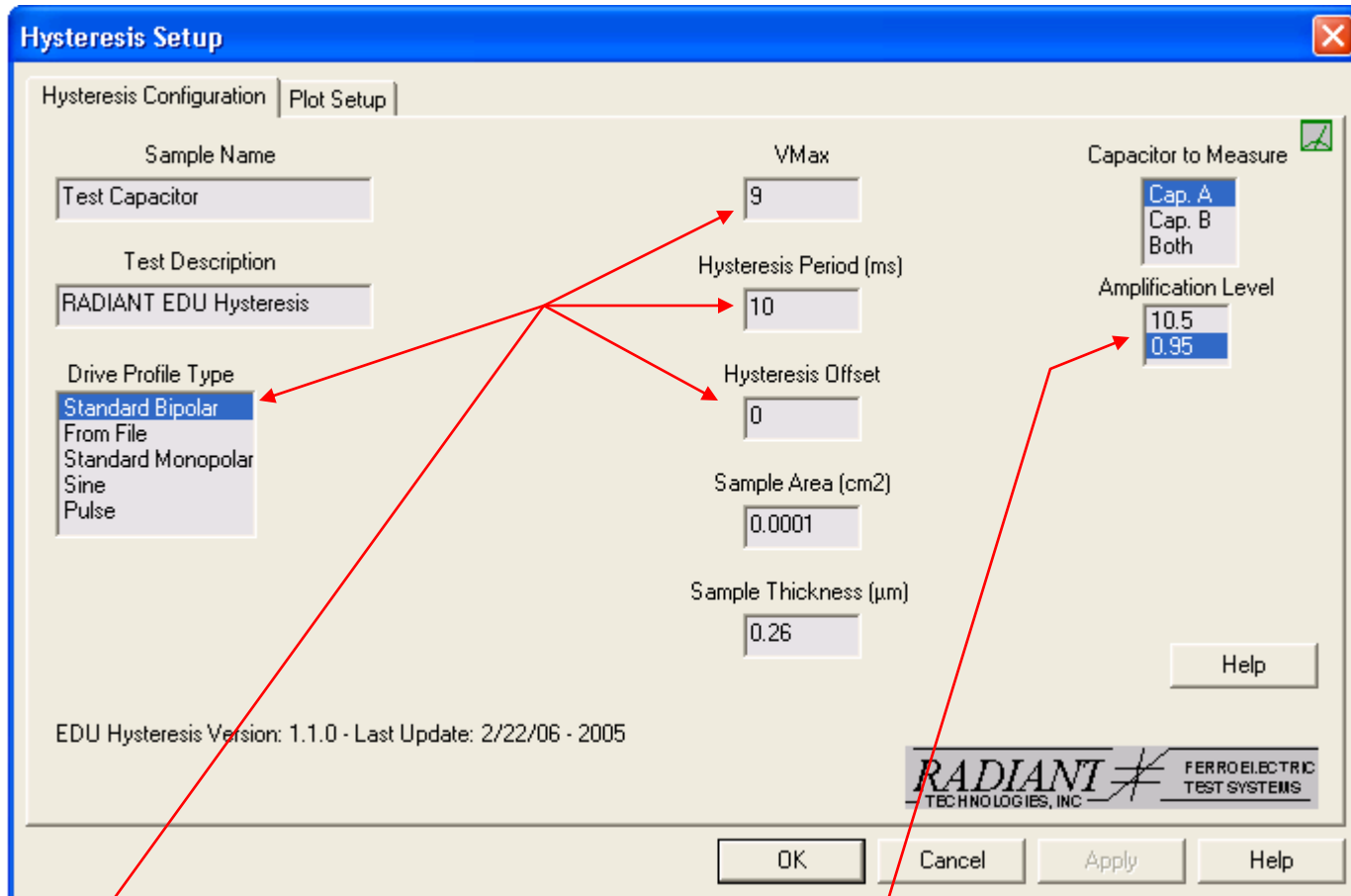

- Four parameters define the test profile. The capacitor values can range from ~10pF to 1nF. Plus, there is an on-board mux to select between Cap A and Cap B in the packaged parts.

Data Plotting

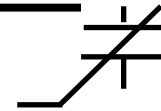

Data Plot Setup

Plot Setup

Plot Title (60 Characters Max.)
Packaged PZT Capacitor

Plot Subtitle (60 Characters Max.)
[Radiant Type AB White]

Plot X Axis Label (60 Characters Max.)
Voltage

Plot Y Axis Label (60 Characters Max.)
Polarization ($\mu\text{C}/\text{cm}^2$)

Data Label (32 Characters Max.)
[]

Display Oscilloscope Data

X-Axis Plot Options
 Plot Voltage
 Plot Field (kV/cm)

Plot Filter
-> <<None>>
Centering
Capacitance (μF) Vs Voltage
Normalized Capacitance ($\mu\text{F}/\text{cm}^2$) Vs Voltage
Polarization Vs Time
Centered Vs Time
C/V Vs Time
Normalized C/V Vs Time

Comments (511 Characters Max.)
[]

Help

OK Cancel Apply Help

Despite its simplicity, the EDU has a powerful set of plotting tools. All of the data displayed on the following pages were taken with an EDU, formatted using EDU plotting tools, and then copied from the EDU GUI directly into the presentation.

Measuring a Linear Capacitor

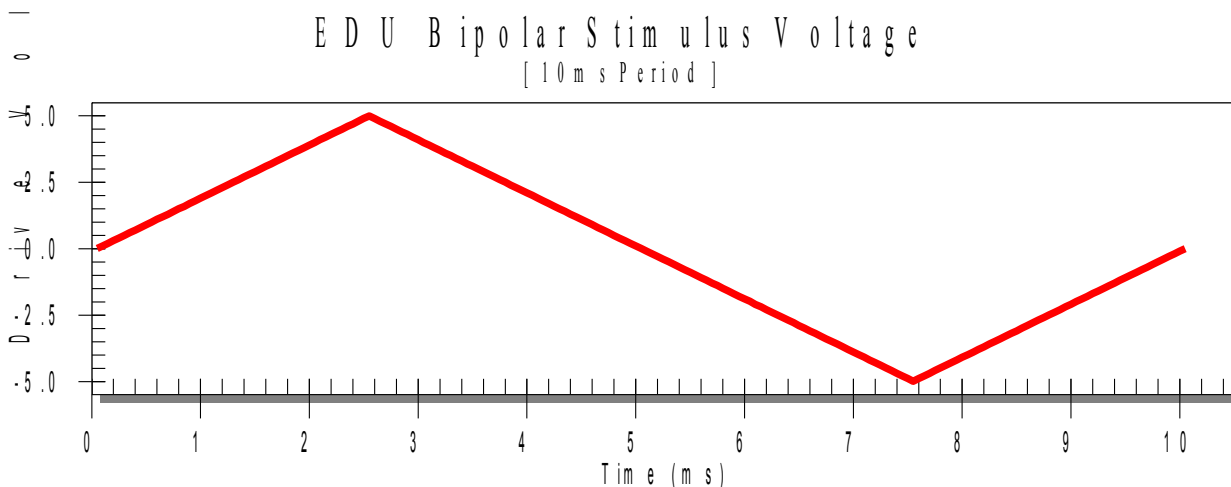
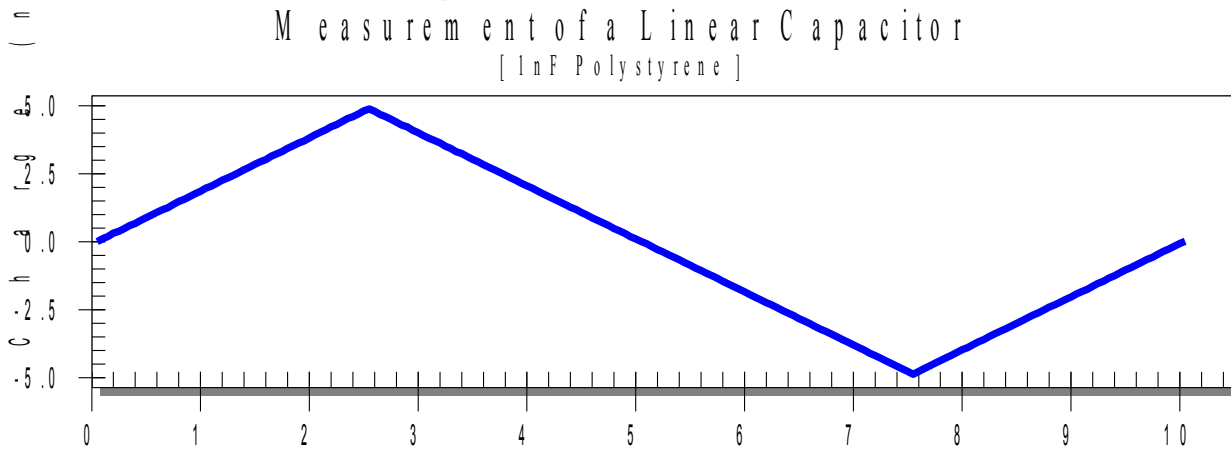

Plots of the voltage stimulus produced by the EDU (called the Drive) versus the charge generated by a linear capacitor in response to the stimulus shown. The linear capacitor is, well, linear!

Radiant Technologies, Inc.

Hysteresis of the Linear Capacitor

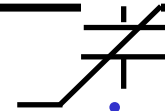

[Charge vs Voltage]

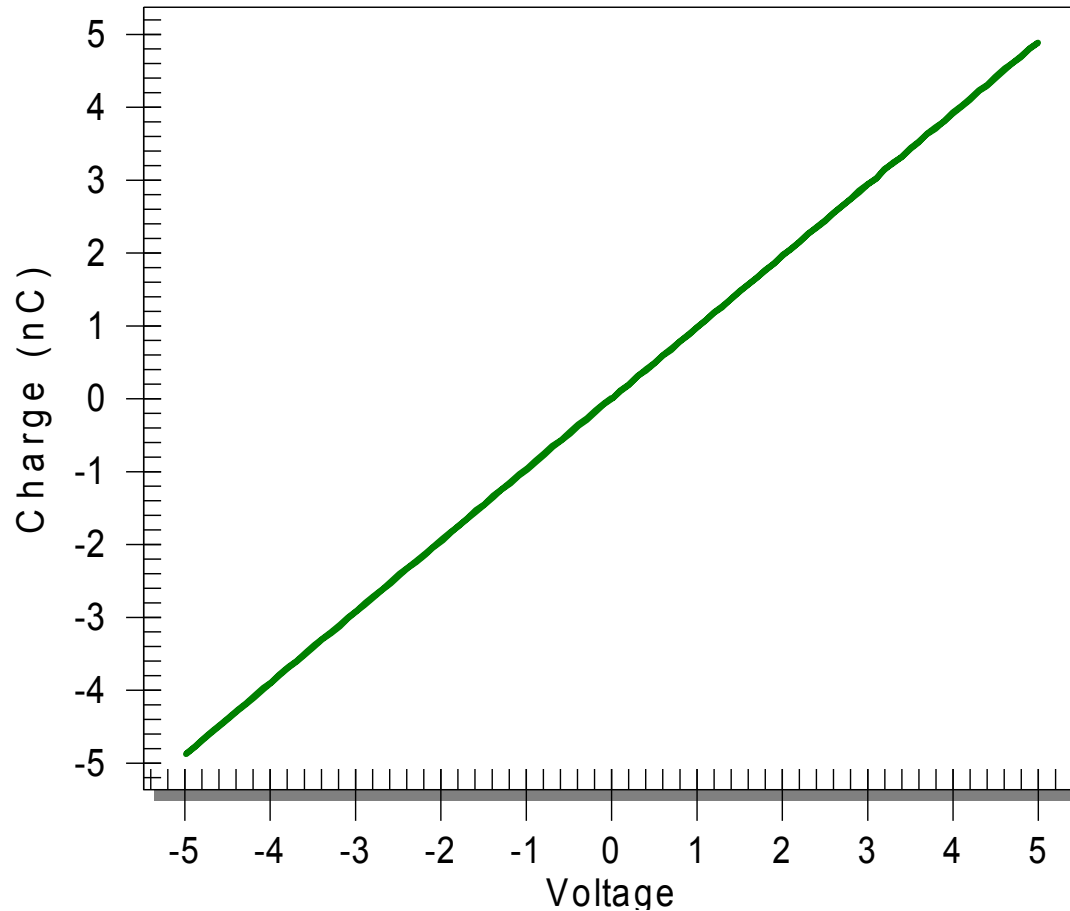

Plotting the measured charge against the voltage on the X-axis yields $Q = CV$. The slope of the line is “C”, the capacitance. This is “hysteresis” data, albeit with zero hysteresis!

Radiant Technologies, Inc.

A PZT Capacitor

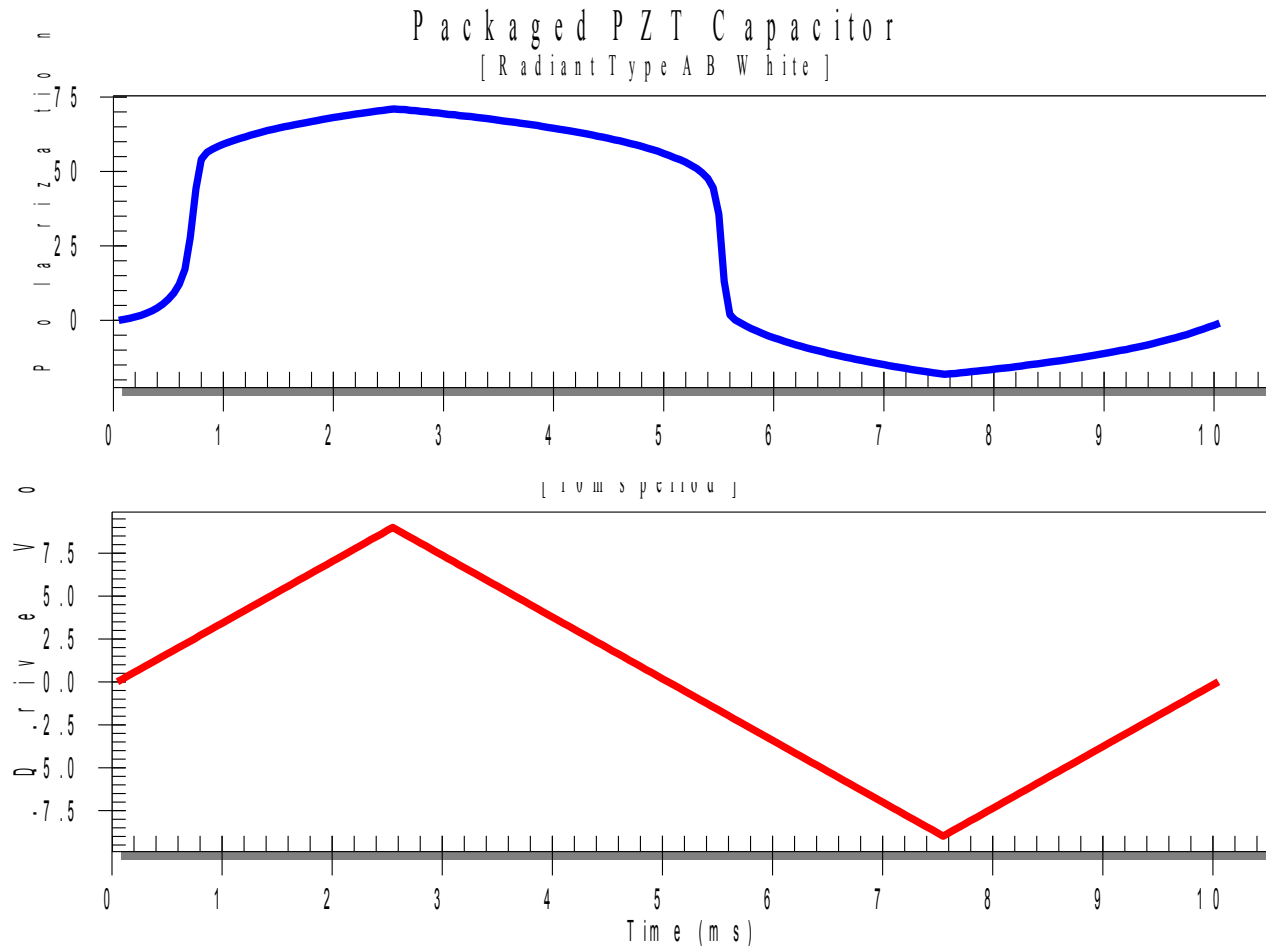
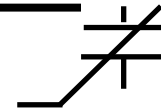

This is a lot more interesting! The ferroelectric material translates the stimulus into a completely different set of temporal frequencies.

Hysteresis of the PZT Capacitor

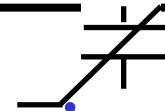

Packaged PZT Capacitor
[Radiant Type AB White]

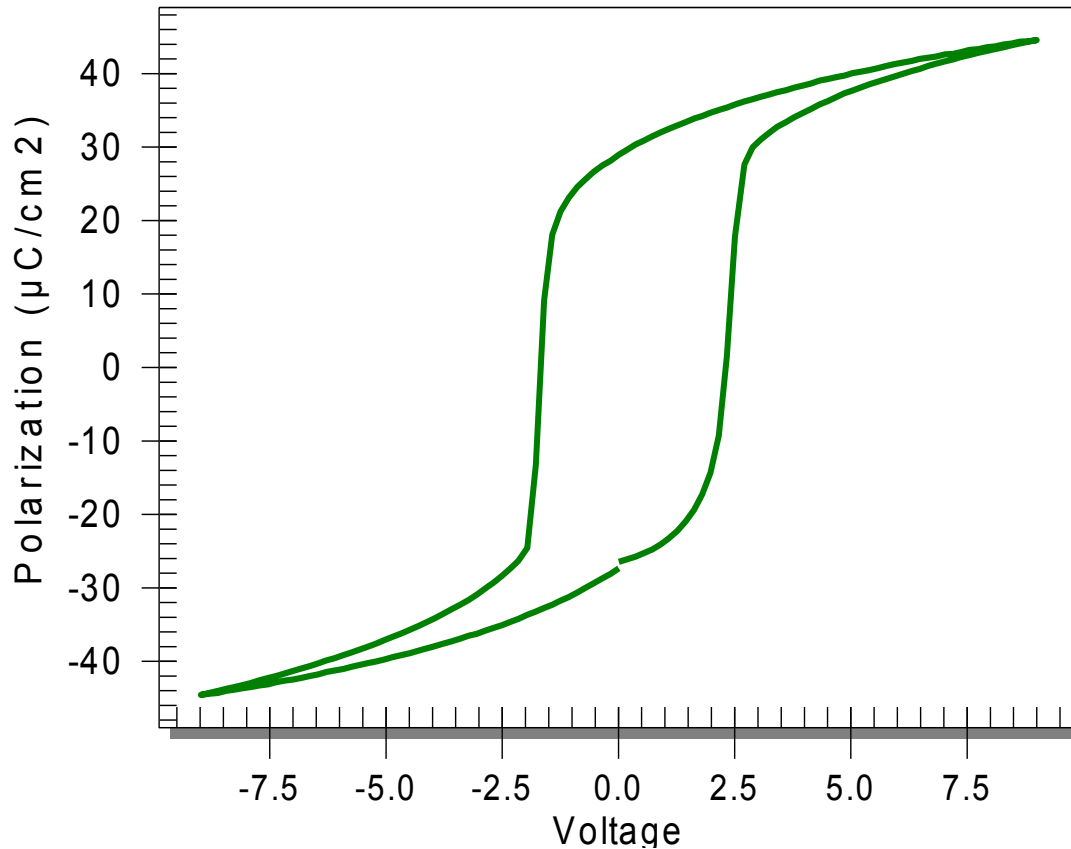

Plotted versus voltage, a real hysteresis emerges.

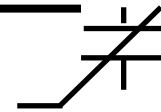

Why does Hysteresis Happen?

All solid materials are held together by a balance of electrical forces exerted between the atoms in material lattices. Normally, atoms in a lattice arrange themselves so that all of the electrons and protons cancel each others' electric fields.

Ferroelectric materials exist with a very complex geometric structure for their lattices. This complexity gives rise to asymmetries in the lattice that prevent all of the electrical fields of the electrons and protons from canceling each other even though there are an even number of electrons and protons. From these asymmetries arise all of the useful properties of ferroelectric materials.

Click on the link to give a short tutorial on the origin of the ferroelectric hysteresis.

[The Origins of Hysteresis](#)

Packaged Ferroelectric Capacitors

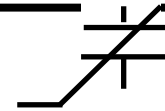

Radiant has designed small packaged ferroelectric capacitors specifically to work with the EDU. The packaged capacitors make it possible for a class to study and use ferroelectric properties in the lab.

- Two capacitors to each package
- Capacitor sizes range from 100,000 square microns down to 100 square microns.

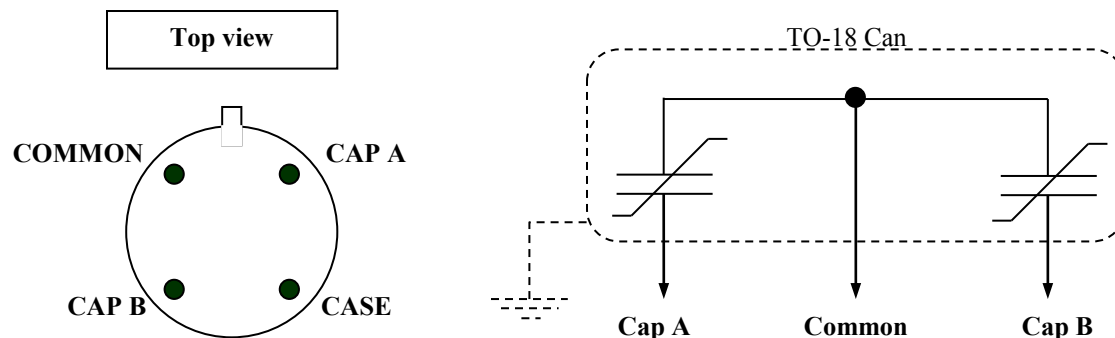

- NOTE: The EDU will only work with capacitors up to 10,000 square microns.

The Packaged Die

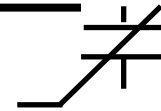

Contact Pad in Gold

PZT

- 0.26 μ 20/80 PZT
- Platinum electrodes
- TiO_x/SiO_x ILD
- Chrome/Gold metallization
- 5V saturation
- Will withstand unlimited exposure to 9V.

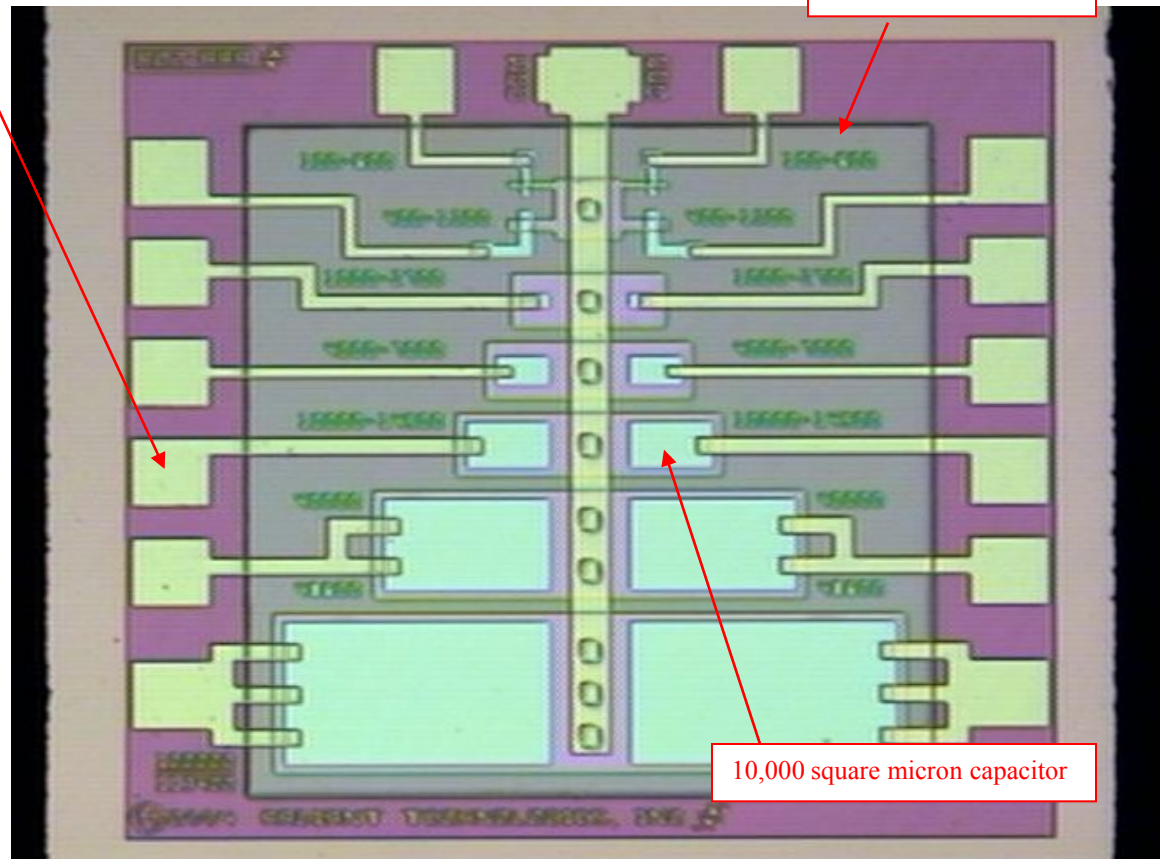

10,000 square micron capacitor

1.4mm

Building Gadgets

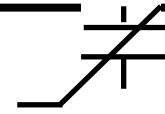

- The EDU has a built-in port, accessible with standard 6-line telephone cable and telephone jack plugs, to allow students to build their own projects and operate them using the EDU software.
- The external port on the Radiant EDU has the following signals:
 - $\pm 10\text{V}$ AWFG output
 - $\pm 10\text{nC}$ electrometer input
 - $\pm 10\text{V}$ oscilloscope input
 - $\pm 15\text{V}$ power and system ground
- Using these signals, the student can build his or her own gadget, power it, stimulate it, and measure it from the EDU.

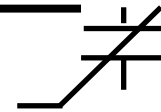

Projects

- Below is short list of interesting projects that can be built and operated with the EDU:
 - Traditional Sawyer Tower measurement circuit for ferroelectric capacitors.
 - FeRAM emulator.
 - FeRAM = Ferroelectric Random Access Memory.
 - Air gap metal plate capacitor
 - PC Board parallel plate capacitor
 - Force sensor.
 - Heat sensor.

Tutorials and Syllabi

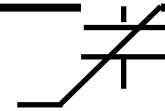

- **Radiant has created a set of tutorials and guided experiments for the EDU.**
 - Eight lessons describe the physics of the dielectric constant, linear capacitors, paraelectric capacitors, and ferroelectric capacitors.
 - The first five experiments familiarize the user with the EDU and its tools.
 - The remaining experiments explain remanent polarization and memory, sensors, test procedures for electro-ceramics, and reliability of electro-ceramics.
 - The tutorials and experiments are installed automatically with the EDU software.
- **Professors are welcome to submit their own contributions to the tutorials or to publish their own syllabi for the unit.**

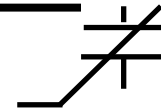

Contact Information

We hope that you have enjoyed our tutorial about the Radiant EDU. You may contact us with questions or recommendations for the EDU and/or new ferroelectric-based components.

- Sales information: Michelle Bell
- Technical assistance: Joe Evans, Bob Howard, or Scott Chapman.
- Shipping instructions: Geri Martinez

- e-mail: radiant@ferrodevices.com
ferromems@ferrodevices.com
- Telephone: 505-842-8007
- Fax: 505-842-0366
- web site: www.ferrodevices.com
www.ferromems.com